

Article number: 437900195

Description: Rota-fix shaft-hub connection SA 195

Measures

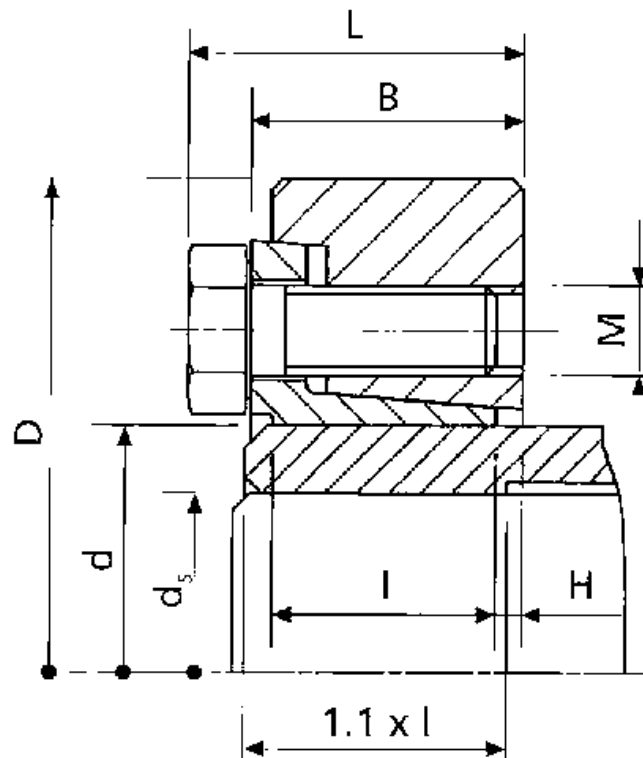

B mm = 85.5
 d H8 mm = 195
 D mm = 340.0
 ds mm = 150
 F kN torque = 1093
 H = 8.0
 I mm = 71.5
 L mm = 96.5

M mm = M16
 T N m torque = 82000
 Ts N m bolt tightening torque = 250